

REVISION RECORD

REV	ECN	DESCRIPTION	DRFT	DATE

H

G

F

E

D

C

B

A

H

G

F

E

D

C

B

A

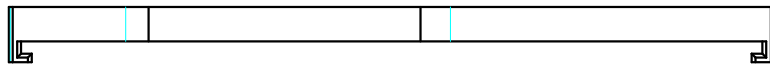
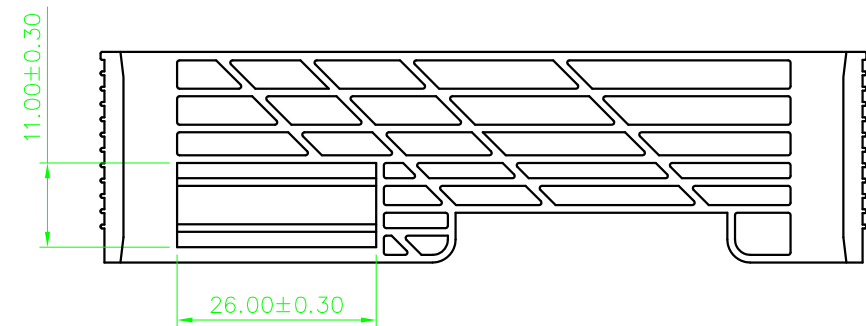
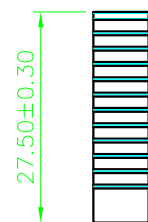
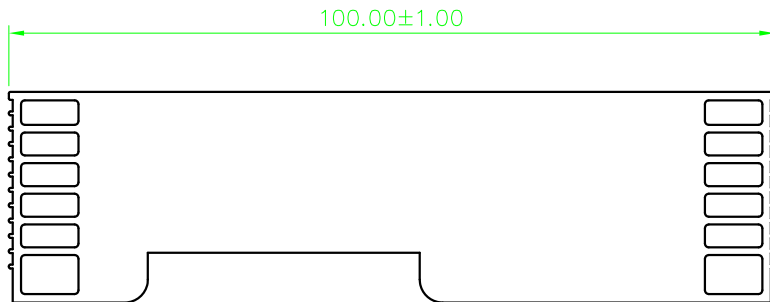
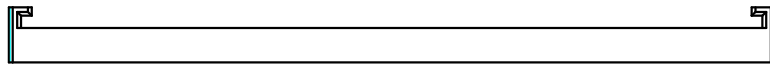

NOTES:
 1.RoHS Compliance
 2.Undimensioned tolerances:

Pitch range in mm				Nominal dimension range in mm					0.1/10
TO 6	Over 6 TO 10	Over 10 TO 24	TO 30	Over 30 TO 60	Over 60 TO 100	Over 100 TO 150	Over 150		
±0.15	±0.20	±0.30	±0.30	±0.50	±0.70	±1.00	±1.30	±2'	

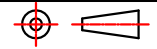
DETACHED LISTS	PART NO.:	 宁波高松电子有限公司 NINGBO DEGSON ELECTRICAL CO., LTD		
	APPD:	NAME: DF750-T-11-00A(H)		
	CHKD:	TITLE: CUSTOMER DRAWING		
	DRFT: WJJ 2020.09.21	REV: D0-1	SHEET: 1/1	SCALE: 1:1
 THIRD ANGLE PROJECTION		DRAWING NO.: MM (INCH)		DO NOT SCALE DRAWING